

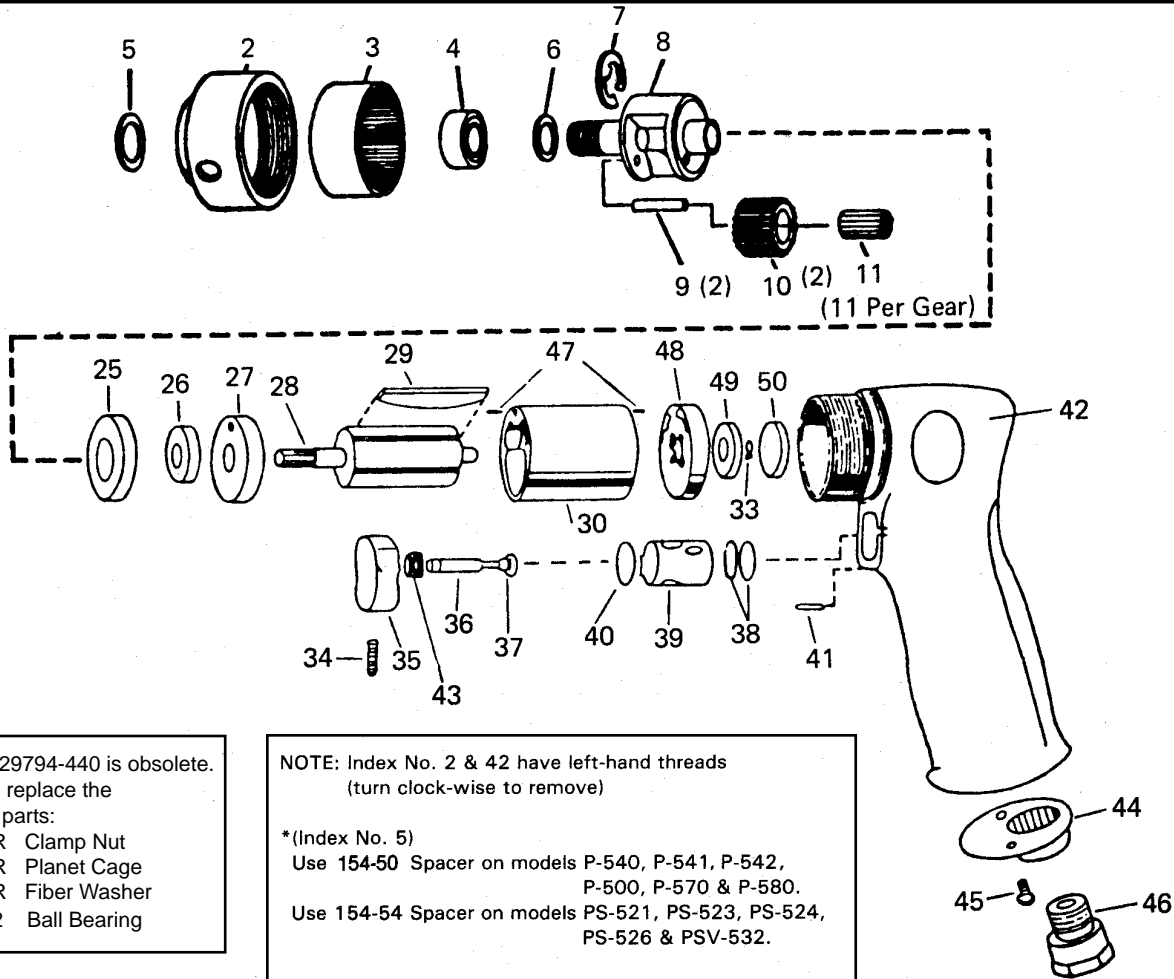

PARTS LIST FOR PNEUMATIC POWER UNITS

253-38 (SERIAL NUMBER 2001 TO 9600)

253-57 (SERIAL NUMBER 9601 & HIGHER)



****Part #729794-440 is obsolete.**
To repair, replace the following parts:
729799-R Clamp Nut
729794-R Planet Cage
729797-R Fiber Washer
49423-02 Ball Bearing

NOTE: Index No. 2 & 42 have left-hand threads (turn clock-wise to remove)

***(Index No. 5)**
Use 154-50 Spacer on models P-540, P-541, P-542, P-500, P-570 & P-580.
Use 154-54 Spacer on models PS-521, PS-523, PS-524, PS-526 & PSV-532.

INDEX NO.	PART NO.	DESCRIPTION	REQ'D TOOL	INDEX NO.	PART NO.	DESCRIPTION	REQ'D TOOL
2	729799-R	Clamp Nut (253-57)	1	29	729709	Rotor Blade	4
	729799-440	Clamp Nut (253-38)	1	30	729708	Cylinder	1
3	729798	Internal Gear	1	33	1012831	Retaining Ring	1
4	49423-02	Ball Bearing (253-57)	1	34	731928	Set Screw	1
	1008854	Ball Bearing (253-38)	1	35	731929	Trigger	1
5	154-*	Spacer	1	36	731926	Valve Stem	1
6	729797-R	Fiber Washer (253-57)	1	37	729591	O-ring	1
	729797	Fiber Washer (253-38)	1	38	729091	O-ring	2
7	729208	Ret. Ring (used only on 253-38)	1	39	731927	Valve Bushing	1
8	729794-R	Planet Cage (253-57)	1	40	729263	O-ring	1
	729794-440	Planet cage (253-38) obsolete**	1	41	731930	Pin	1
9	729796-440	Planet Pin	2	42	731923-440	Motor Housing	1
10	729795	Planet Gear (incl. 729808 Needle Rollers)	2	43	731925	Valve Spring	1
11	729808	Needle Rollers (see 729795 Planet Gear)	22	44	731922	Housing End Cap	1
25	1008212	Ball Bearing	1	45	731921	Screw	2
26	1001532	Ball Bearing	1	46	731920	Air Inlet	1
27	729793	Front Plate	1	47	729707	Dowel Pin	2
28	729792	Rotor	1	48	729791	Rear Plate	1
				49	729012	Ball Bearing	1
				50	729178	Bearing Seal	1



INSTRUCTIONS FOR THE CARE OF THE KETT 95-20 SHEAR HEAD

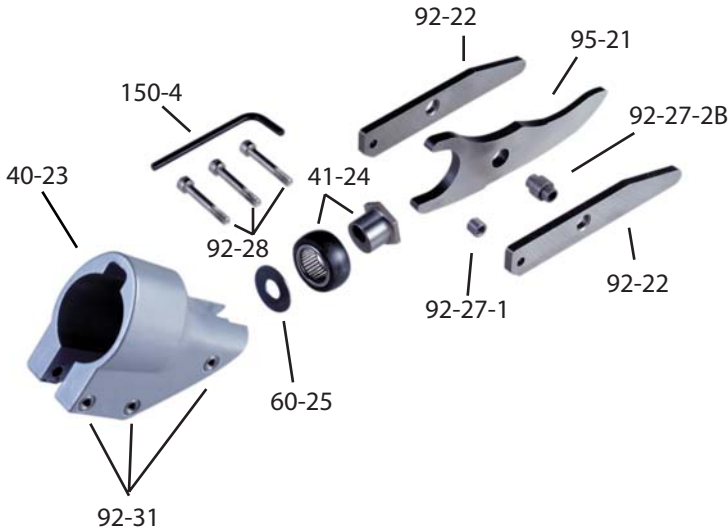

CAUTION
Disconnect Power Unit
Before Servicing Tool

PARTS LIST

95-21	Center Blade
92-22	Side Knife (2)
40-23	Shear Housing
41-24	Eccentric Bearing Assembly
92-27-2B	Spacer Bushing
92-27-1	Spacer Bushing
92-28	Cap Screw (3)
92-31	Knurled Insert (3)
60-25	Thin Washer, Large
150-4	Allen Wrench

DISASSEMBLY: To remove the shear head from the motor loosen three cap screws (92-28). Remove shear head from motor by pulling head firmly forward. Slight tapping with a mallet may be required if head does not slide off easily.

To remove cutter blades from shear head remove three cap screws (92-28) from shear housing (40-23). Be careful not to lose rear spacer bushing (92-27-1) when removing the middle cap screw. Remove center blade (95-21) from shear housing by tapping blade gently rearward. Be careful not to lose spacer bushing (92-27-2B) from hole in center blade. Side knives (90-22) will now drop out of the shear housing.

To remove eccentric bearing assembly (41-24) from shaft use an appropriate wrench to loosen eccentric nut by turning counter clockwise.

ASSEMBLY: To install eccentric bearing assembly (41-24) onto shaft, make sure the large thin washer (60-25) is first inserted over the shaft. Screw eccentric bearing assembly on to shaft and tighten with appropriate wrench. Lubricate bearing with a good grade of bearing grease.

To install cutter blades into shear housing (40-23) place the side knives (92-22) into position in the

shear housing (40-23). Insert center cap screw (92-28) through the side knives (92-22) with rear spacer bushing (92-27-1) between them and start cap screw into thread just enough to hold blades in place. **DO NOT TIGHTEN.** Insert spacer bushing (92-27-2B) into hole in center blade (95-21) and lubricate with Molybdenum Disulfide grease (264-2) or equivalent. Install center blade into shear housing by tapping blade gently forward using a drift to line up hole in center blade with forward holes in housing. Insert and tighten forward cap screw (92-28) making sure spacer bushing (92-27-2B) in center blade stays in position. Apply Molybdenum Disulfide grease (264-2) or equivalent to clevis or yoke in center blade where it rides on the eccentric bearing assembly. Insert rear cap screw (92-28) into shear housing, but do not completely tighten.

To install shear head assembly onto drive motor make sure all cap screws (92-28) are loosened about three or four complete turns. Spread shear housing (40-23) slightly using a spreader (drift) near the rear cap screw (92-28). Place shear head onto unit, tap left side knife rearward as far as it will go, and tighten cap screws to 40-45 inch pounds. It may be necessary to gently tap the shear head into place if it does not readily slip onto the nose of the power unit.

WARNING: THE KETT TOOL CO. CANNOT ASSUME RESPONSIBILITY FOR DAMAGE TO OR MALFUNCTION OF A KETT SHEAR HEAD USED IN COMBINATION WITH ANY DRILL OTHER THAN THOSE REGULARLY SUPPLIED BY US.